

FEATURES

- Very low voltage noise: 1.8 nV/ $\sqrt{\text{Hz}}$**
- Low input bias current: 90 nA maximum**
- Offset voltage: 125 μV maximum**
- High gain: 120 dB**
- Wide bandwidth: 12 MHz**
- $\pm 5\text{ V}$ to $\pm 15\text{ V}$ operation**

APPLICATIONS

- Precision instrumentation**
- Filter blocks**
- Microphone preamplifiers**
- Industrial control**
- Thermocouples and RTDs**
- Reference buffers**

GENERAL DESCRIPTION

The ADA4004-1/ADA4004-2/ADA4004-4 are 1.8 nV/ $\sqrt{\text{Hz}}$ precision amplifiers featuring 40 μV offset, 0.7 $\mu\text{V}/^\circ\text{C}$ drift, 12 MHz bandwidth, and low 1.7 mA per amplifier supply current.

The ADA4004-1/ADA4004-2/ADA4004-4 are designed on the high performance *iPolar*[™] process, enabling improvements such as reduced noise and power consumption, increased speed and stability, and smaller footprint size. Novel design techniques enable the ADA4004-1/ADA4004-2/ADA4004-4 to achieve 1.8 nV/ $\sqrt{\text{Hz}}$ voltage noise density and a low 6 Hz 1/f noise corner frequency while consuming just 1.7 mA per amplifier. The small package saves board space, reduces cost, and improves layout flexibility.

Applications for these amplifiers include high precision controls, PLL filters, high performance precision filters, medical and analytical instrumentation, precision power supply controls, ATE, and data acquisition systems. Operation is fully specified from $\pm 5\text{ V}$ to $\pm 15\text{ V}$ from -40°C to $+125^\circ\text{C}$.

The ADA4004-1, ADA4004-2, and ADA4004-4 are members of a growing series of low noise op amps offered by Analog Devices, Inc. (see Table 1).

Table 1. Voltage Noise

Pkg.	0.9 nV	1.1 nV	1.8 nV	2.8 nV	3.8 nV
Single	AD797	AD8597	ADA4004-1	AD8675	AD8671
Dual		AD8599	ADA4004-2	AD8676	AD8672
Quad			ADA4004-4		AD8674

PIN CONFIGURATIONS

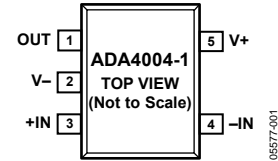

Figure 1. 5-Lead SOT (RJ-5)

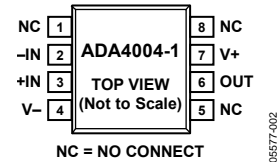

Figure 2. 8-Lead SOIC (R-8)

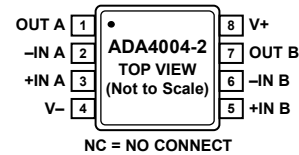

Figure 3. 8-Lead MSOP (RM-8) and 8-Lead SOIC (R-8)

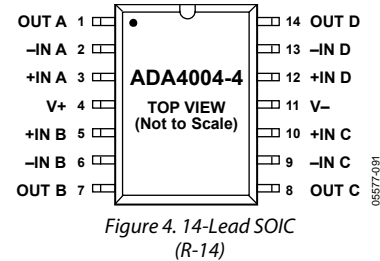
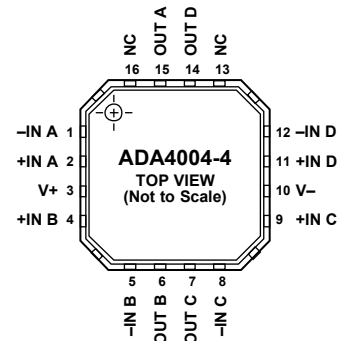

Figure 4. 14-Lead SOIC (R-14)



- NOTES
 1. NC = NO CONNECT.
 2. IT IS RECOMMENDED THAT THE EXPOSED PAD BE CONNECTED TO V-.

Figure 5. 16-Lead LFCSP (CP-16-4)

Rev. G

Information furnished by Analog Devices is believed to be accurate and reliable. However, no responsibility is assumed by Analog Devices for its use, nor for any infringements of patents or other rights of third parties that may result from its use. Specifications subject to change without notice. No license is granted by implication or otherwise under any patent or patent rights of Analog Devices. Trademarks and registered trademarks are the property of their respective owners.

TABLE OF CONTENTS

Features 1
 Applications..... 1
 General Description 1
 Pin Configurations 1
 Revision History 2
 Specifications..... 3

Absolute Maximum Ratings5
 Thermal Resistance5
 ESD Caution.....5
 Typical Performance Characteristics6
 Outline Dimensions 12
 Ordering Guide 14

REVISION HISTORY

4/11—Rev. F to Rev. G

Changes to Figure 1 1
 Updated Outline Dimensions 12

6/10—Rev. E to Rev. F

Added Differential Input Current to Table 4 5
 Changes to Figure 14 and Figure 17 7

10/09—Rev. D to Rev. E

Changes to Product Title, General Description Section, and Figure 5 1
 Updated Outline Dimensions (RM-8)..... 13
 Changes to Ordering Guide 14

6/09—Rev. C to Rev. D

Changes to Figure 5 1

10/08—Rev. B to Rev. C

Added ADA4004-1 and ADA4004-2 Universal
 Added 5-Lead SOT, 8-Lead SOIC, and 8-Lead MSOP Universal
 Changes to Features Section 1
 Added Figure 1 to Figure 3; Renumbered Sequentially..... 1
 Changes to General Description Section 1
 Added Table 1; Renumbered Sequentially 1
 Change to Output Voltage Low Parameter, Table 2 3
 Changes to Supply Current per Amplifier Parameter, Table 2..... 3
 Added Phase Margin Parameter, Table 2 3
 Change to Output Voltage Low Parameter, Table 3 3
 Changes to Supply Current per Amplifier Parameter, Table 3..... 4
 Added Phase Margin Parameter, Table 3 4
 Changes to Table 4..... 5
 Changes to Thermal Resistance Section..... 5
 Changes to Table 5 5
 Update Outline Dimensions..... 12
 Changes to Ordering Guide..... 13

11/07—Rev. A to Rev. B

Changed V_S to V_{SY} Universal
 Changes to General Description1
 Changes to Supply Current per Amplifier3
 Changes to Open-Loop Gain.....4
 Changes to Supply Current per Amplifier4
 Changes to Figure 10, Figure 11, Figure 13, and Figure 14.....7
 Changes to Figure 26.....9
 Updated Outline Dimensions..... 12
 Changes to Ordering Guide 12

7/06—Rev. 0 to Rev. A

Changes to Table 4.....5
 Updated Outline Dimensions 12
 Changes to Ordering Guide 12

1/06—Revision 0: Initial Version

SPECIFICATIONS

$V_{SY} = \pm 5\text{ V}$, $V_{CM} = 0\text{ V}$, $T_A = 25^\circ\text{C}$, unless otherwise specified.

Table 2.

Parameter	Symbol	Conditions	Min	Typ	Max	Unit
INPUT CHARACTERISTICS						
Offset Voltage	V_{OS}	$-40^\circ\text{C} \leq T_A \leq +125^\circ\text{C}$		40	140	μV
Input Bias Current	I_B	$-40^\circ\text{C} \leq T_A \leq +125^\circ\text{C}$		40	85	nA
Input Offset Current	I_{OS}	$-40^\circ\text{C} \leq T_A \leq +125^\circ\text{C}$		40	85	nA
Input Voltage Range	IVR	$-40^\circ\text{C} \leq T_A \leq +125^\circ\text{C}$	-3.5		+3.5	V
Common-Mode Rejection Ratio	CMRR	$V_{CM} = -3.0\text{ V to }+3.0\text{ V}$ $-40^\circ\text{C} \leq T_A \leq +125^\circ\text{C}$	105	111		dB
Open-Loop Gain	A_{VO}	$R_L = 2\text{ k}\Omega$, $V_{OUT} = -2.5\text{ V to }+2.5\text{ V}$ $-40^\circ\text{C} \leq T_A \leq +125^\circ\text{C}$	250	400		V/mV
Offset Voltage Drift	$\Delta V_{OS}/\Delta T$	$-40^\circ\text{C} \leq T_A \leq +125^\circ\text{C}$		0.7	1	$\mu\text{V}/^\circ\text{C}$
OUTPUT CHARACTERISTICS						
Output Voltage High	V_{OH}	$R_L = 2\text{ k}\Omega$ to ground $-40^\circ\text{C} \leq T_A \leq +125^\circ\text{C}$	3.7	3.9		V
Output Voltage Low	V_{OL}	$R_L = 2\text{ k}\Omega$ to ground $-40^\circ\text{C} \leq T_A \leq +125^\circ\text{C}$	3.4	3.6		V
Short-Circuit Limit	I_{SC}	$-40^\circ\text{C} \leq T_A \leq +125^\circ\text{C}$		25	-3.6	mA
Output Current	I_O	$V_{OUT} = \pm 3.6\text{ V}$		± 10	-3.4	mA
POWER SUPPLY						
Power Supply Rejection Ratio	PSRR	$V_{SY} = \pm 5\text{ V to } \pm 15\text{ V}$ $-40^\circ\text{C} \leq T_A \leq +125^\circ\text{C}$	110	118		dB
Supply Current per Amplifier	I_{SY}	$-40^\circ\text{C} \leq T_A \leq +125^\circ\text{C}$	110		2.0	mA
DYNAMIC PERFORMANCE						
Slew Rate	SR	$R_L = 2\text{ k}\Omega$ to ground		2.7		$\text{V}/\mu\text{s}$
Gain Bandwidth Product	GBP			12		MHz
Phase Margin	Φ_M			48		Degrees
NOISE PERFORMANCE						
Voltage Noise	$e_{n\text{ p-p}}$	$f = 0.1\text{ Hz to }10\text{ Hz}$		0.1		$\mu\text{V p-p}$
Voltage Noise Density	e_n	$f = 1\text{ kHz}$		1.8		$\text{nV}/\sqrt{\text{Hz}}$
Current Noise Density	i_n	$f = 10\text{ Hz}$		3.5		$\text{pA}/\sqrt{\text{Hz}}$
Current Noise Density	i_n	$f = 200\text{ Hz}$		1.2		$\text{pA}/\sqrt{\text{Hz}}$

ADA4004-1/ADA4004-2/ADA4004-4

$V_{SY} = \pm 15\text{ V}$, $V_{CM} = 0\text{ V}$, $T_A = 25^\circ\text{C}$, unless otherwise specified.

Table 3.

Parameter	Symbol	Conditions	Min	Typ	Max	Unit
INPUT CHARACTERISTICS						
Offset Voltage	V_{OS}	$-40^\circ\text{C} \leq T_A \leq +125^\circ\text{C}$		40	125	μV
Input Bias Current	I_B	$-40^\circ\text{C} \leq T_A \leq +125^\circ\text{C}$		40	90	nA
Input Offset Current	I_{OS}	$-40^\circ\text{C} \leq T_A \leq +125^\circ\text{C}$			165	nA
Input Voltage Range	IVR	$-40^\circ\text{C} \leq T_A \leq +125^\circ\text{C}$	-12.5		100	V
Common-Mode Rejection Ratio	CMRR	$V_{CM} = -12.5\text{ V to } +12.5\text{ V}$ $-40^\circ\text{C} \leq T_A \leq +125^\circ\text{C}$	110	113		dB
Open-Loop Gain	A_{VO}	$R_L = 2\text{ k}\Omega$, $V_{OUT} = -12.0\text{ V to } +12.0\text{ V}$ $-40^\circ\text{C} \leq T_A \leq +125^\circ\text{C}$	500	1200		V/mV
Offset Voltage Drift	$\Delta V_{OS}/\Delta T$	$-40^\circ\text{C} \leq T_A \leq +125^\circ\text{C}$		0.7	1	$\mu\text{V}/^\circ\text{C}$
OUTPUT CHARACTERISTICS						
Output Voltage High	V_{OH}	$R_L = 2\text{ k}\Omega$ to ground $-40^\circ\text{C} \leq T_A \leq +125^\circ\text{C}$	13.4	13.6		V
Output Voltage Low	V_{OL}	$R_L = 2\text{ k}\Omega$ to ground $-40^\circ\text{C} \leq T_A \leq +125^\circ\text{C}$	13.1	13.3		V
Short-Circuit Limit	I_{SC}			25		mA
Output Current	I_O	$V_{OUT} = \pm 13.6\text{ V}$		± 10		mA
POWER SUPPLY						
Power Supply Rejection Ratio	PSRR	$V_{SY} = \pm 5\text{ V to } \pm 15\text{ V}$ $-40^\circ\text{C} \leq T_A \leq +125^\circ\text{C}$	110	118		dB
Supply Current per Amplifier	I_{SY}	$-40^\circ\text{C} \leq T_A \leq +125^\circ\text{C}$	110		2.2	dB
					2.4	mA
DYNAMIC PERFORMANCE						
Slew Rate	SR	$R_L = 2\text{ k}\Omega$ to ground		2.7		V/ μs
Gain Bandwidth Product	GBP			12		MHz
Phase Margin	Φ_M			48		Degrees
NOISE PERFORMANCE						
Voltage Noise	$e_{n,p-p}$	$f = 0.1\text{ Hz to } 10\text{ Hz}$		0.15		$\mu\text{V p-p}$
Voltage Noise Density	e_n	$f = 1\text{ kHz}$		1.8		nV/ $\sqrt{\text{Hz}}$
Current Noise Density	i_n	$f = 10\text{ Hz}$		3.5		pA/ $\sqrt{\text{Hz}}$
Current Noise Density	i_n	$f = 200\text{ Hz}$		1.2		pA/ $\sqrt{\text{Hz}}$

ABSOLUTE MAXIMUM RATINGS

Table 4.

Parameter	Rating
Supply Voltage	±18 V or +36 V
Input Voltage	$V_- < V_{IN} < V_+$
Differential Input Voltage	±V supply
Differential Input Current	±5 mA
Output Short-Circuit Duration to GND	Indefinite
Storage Temperature Range	−65°C to +150°C
Operating Temperature Range	−40°C to +125°C
Junction Temperature Range	−65°C to +150°C
Lead Temperature (Soldering 60 sec)	300°C

Stresses above those listed under Absolute Maximum Ratings may cause permanent damage to the device. This is a stress rating only; functional operation of the device at these or any other conditions above those indicated in the operational section of this specification is not implied. Exposure to absolute maximum rating conditions for extended periods may affect device reliability.

THERMAL RESISTANCE

θ_{JA} is specified with the device soldered on a circuit board with its exposed paddle soldered to a pad (if applicable) on a 4-layer JEDEC standard printed circuit board with zero airflow.

Table 5.

Package Type	θ_{JA}	θ_{JC}	Unit
5-Lead SOT (RJ-5)	230	92	°C/W
8-Lead SOIC (R-8), ADA4004-1	177	53	°C/W
8-Lead SOIC (R-8), ADA4004-2	155	45	°C/W
8-Lead MSOP (RM-8)	186	52	°C/W
14-Lead SOIC_N (R-14)	115	36	°C/W
16-Lead LFCSP_VQ (CP-16-4)	44	31.5	°C/W

ESD CAUTION



ESD (electrostatic discharge) sensitive device. Charged devices and circuit boards can discharge without detection. Although this product features patented or proprietary protection circuitry, damage may occur on devices subjected to high energy ESD. Therefore, proper ESD precautions should be taken to avoid performance degradation or loss of functionality.

TYPICAL PERFORMANCE CHARACTERISTICS

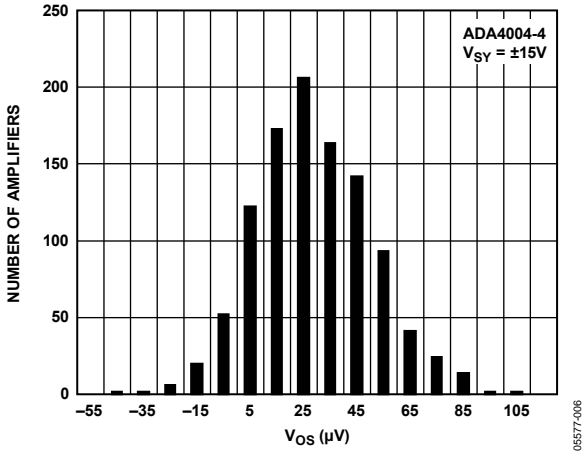

Figure 6. Number of Amplifiers vs. Input Offset Voltage

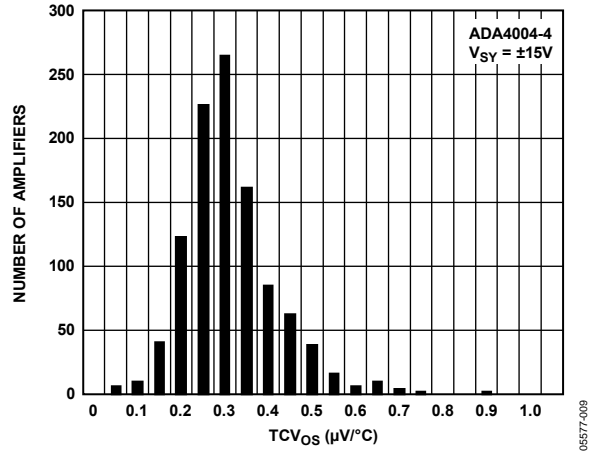

Figure 9. Number of Amplifiers vs. TCV_{OS}

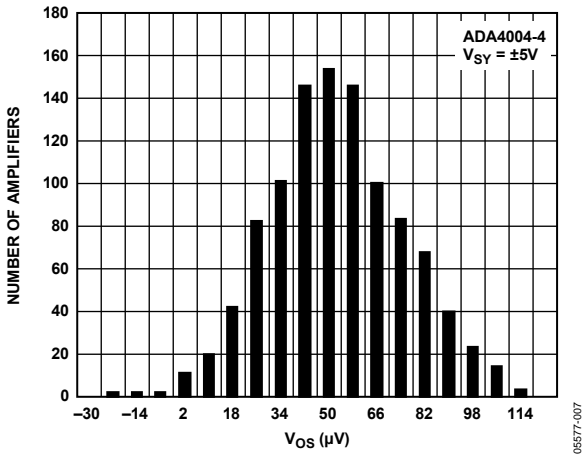

Figure 7. Number of Amplifiers vs. Input Offset Voltage

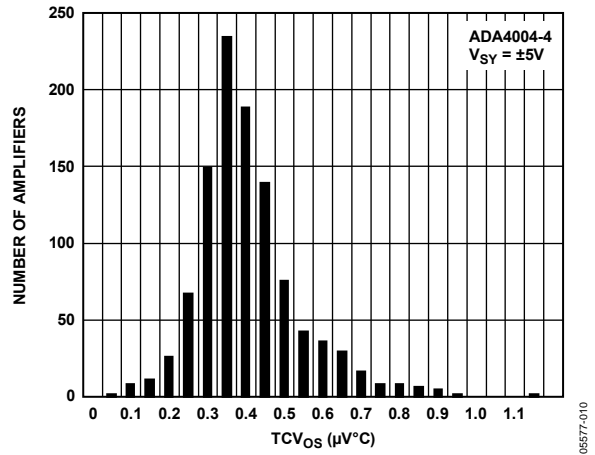

Figure 10. Number of Amplifiers vs. TCV_{OS}

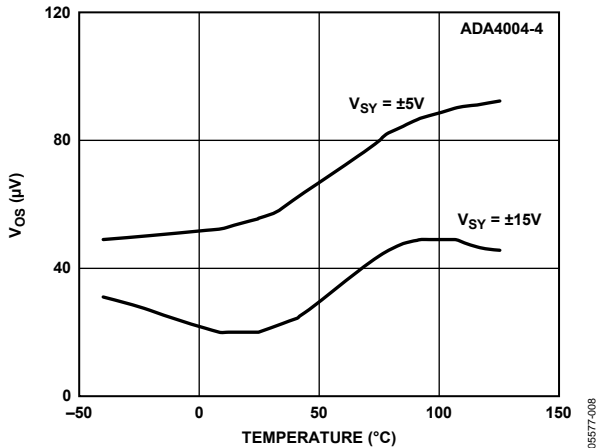

Figure 8. Input Offset Voltage vs. Temperature

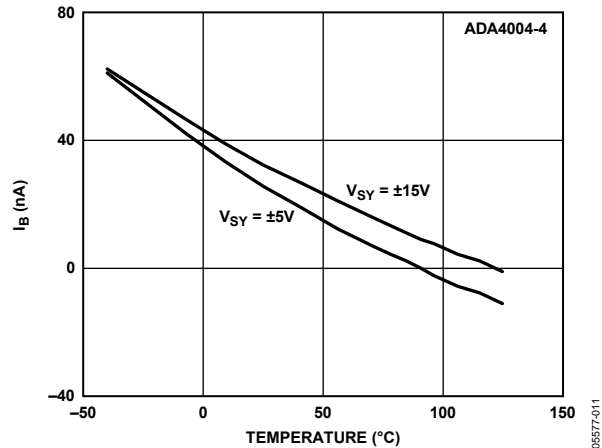

Figure 11. Input Bias Current vs. Temperature



Figure 12. Supply Current vs. Total Supply Voltage



Figure 15. Supply Current vs. Temperature



Figure 13. V_{OH} vs. Temperature



Figure 16. V_{OL} vs. Temperature

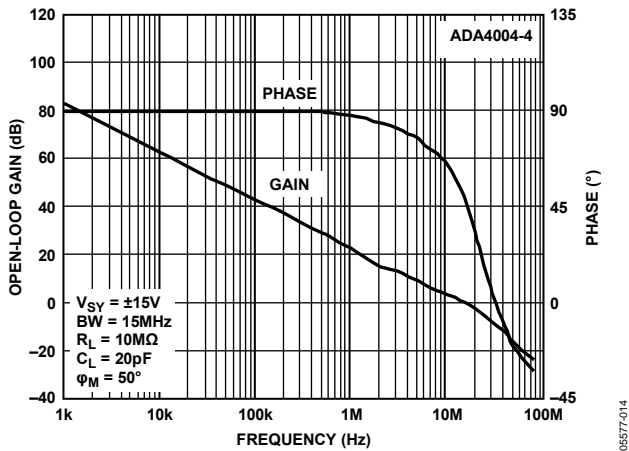

Figure 14. Open-Loop Gain and Phase vs. Frequency

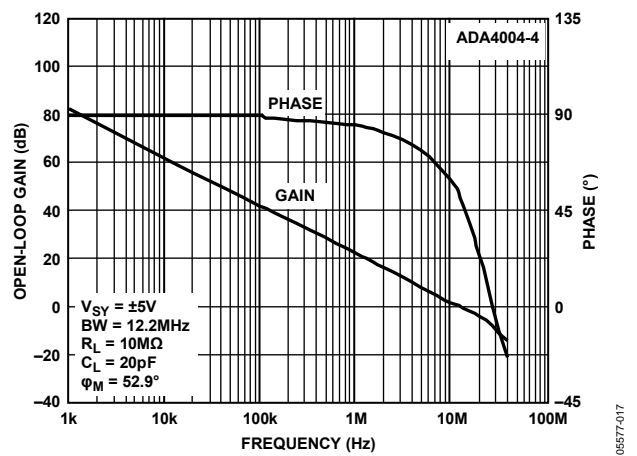

Figure 17. Open-Loop Gain and Phase vs. Frequency

ADA4004-1/ADA4004-2/ADA4004-4

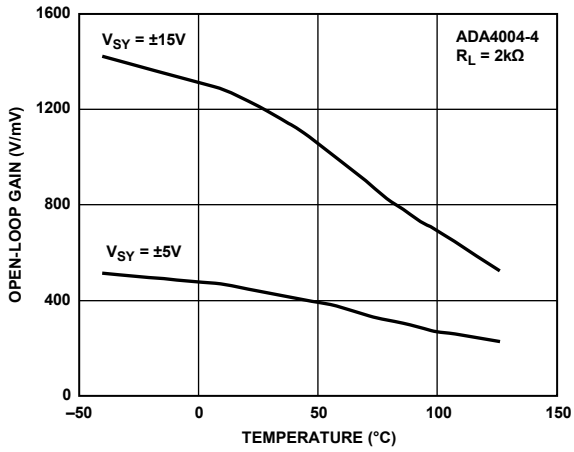

Figure 18. Open-Loop Gain vs. Temperature

05577-018

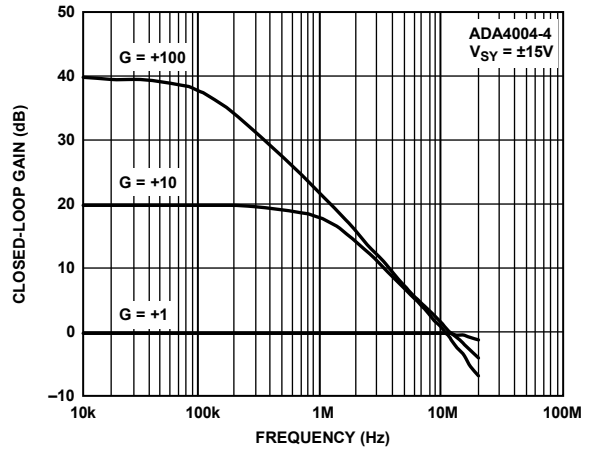

Figure 21. Closed-Loop Gain vs. Frequency

05577-021

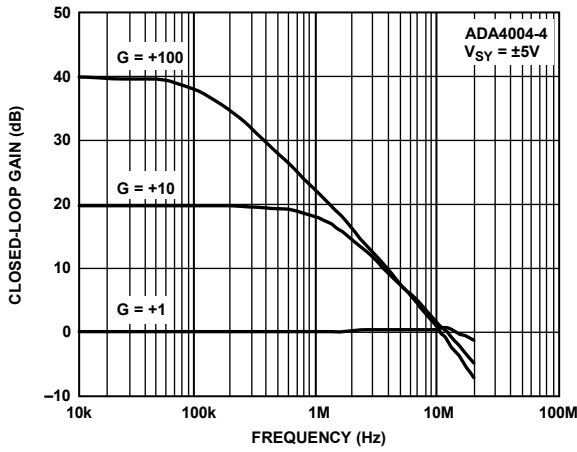

Figure 19. Closed-Loop Gain vs. Frequency

05577-019

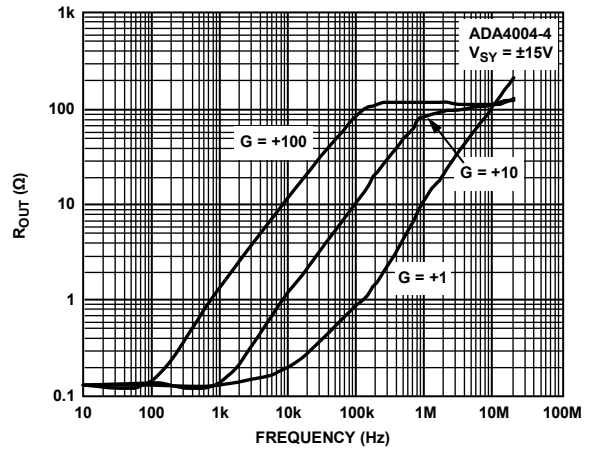

Figure 22. Output Impedance vs. Frequency

05577-022

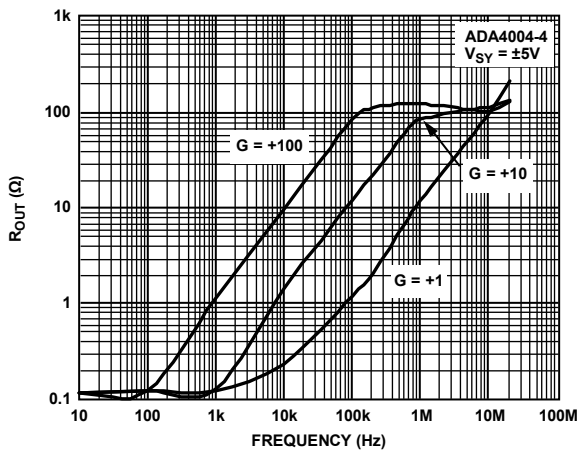

Figure 20. Output Impedance vs. Frequency

05577-020

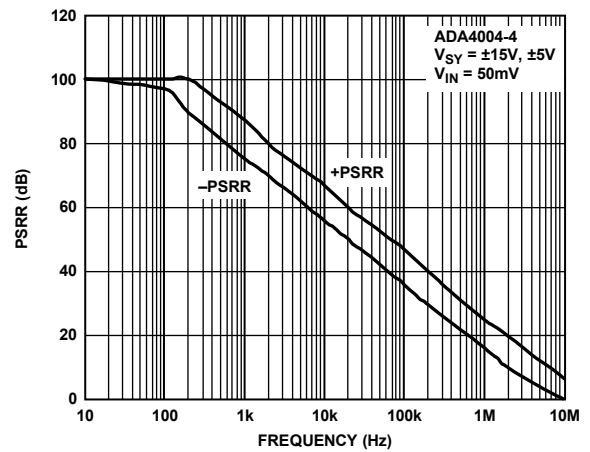

Figure 23. PSRR vs. Frequency

05577-023



Figure 24. PSRR vs. Temperature

06577-024

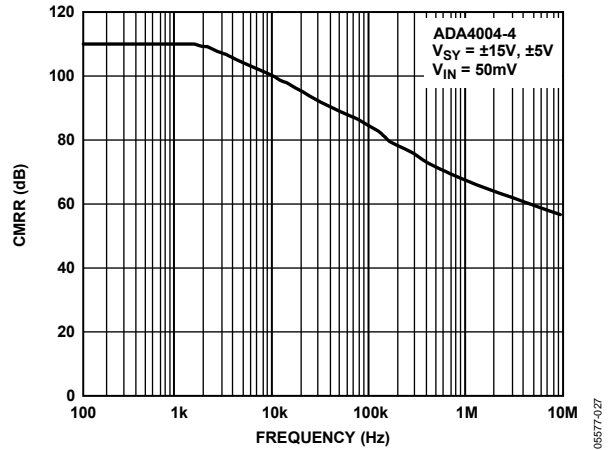

Figure 27. CMRR vs. Frequency

06577-027

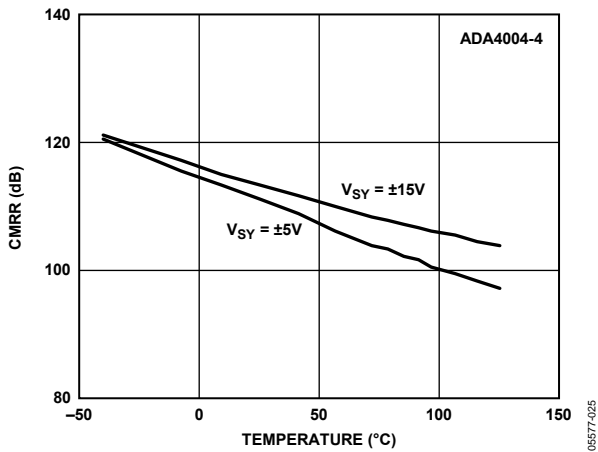

Figure 25. CMRR vs. Temperature

06577-025

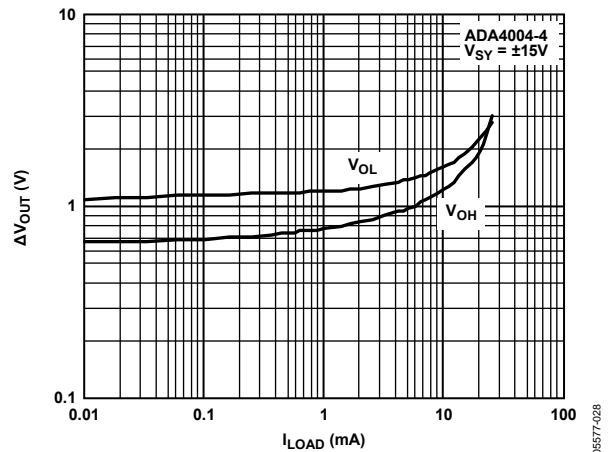

Figure 28. Output Voltage vs. Current Load

06577-028

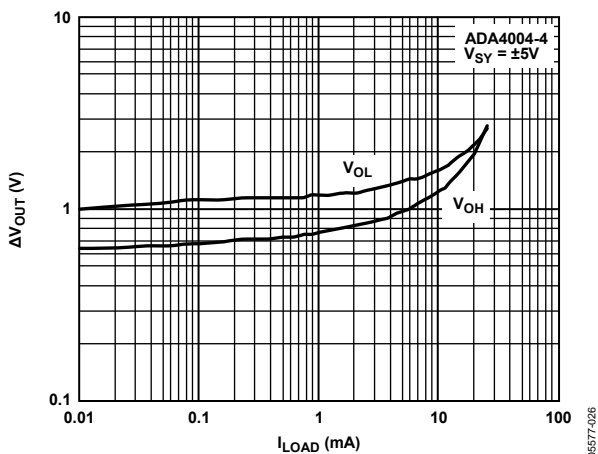

Figure 26. Output Voltage vs. Current Load

06577-026

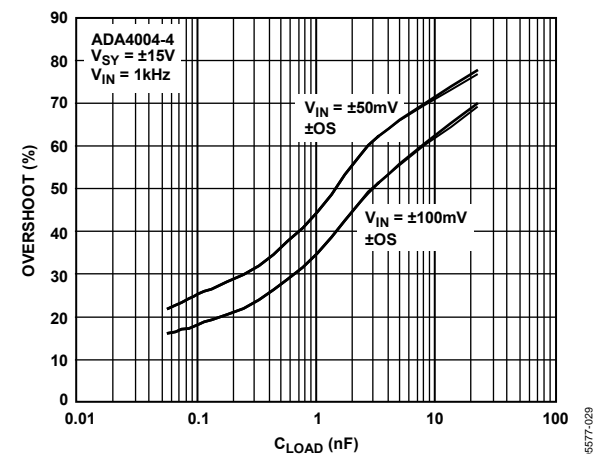

Figure 29. Small-Signal Overshoot vs. Capacitive Load

06577-029

ADA4004-1/ADA4004-2/ADA4004-4

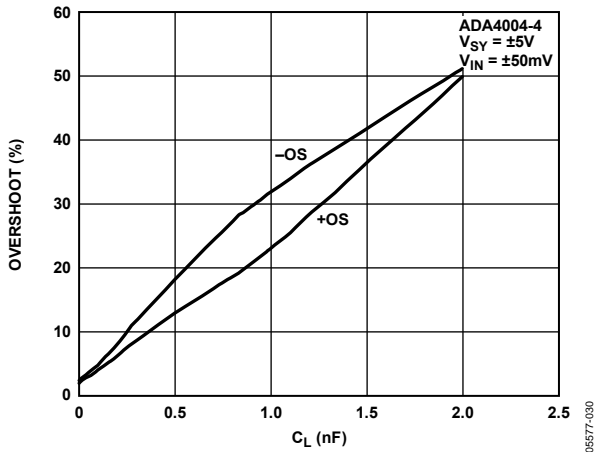

Figure 30. Small-Signal Overshoot vs. Capacitive Load

05577-030

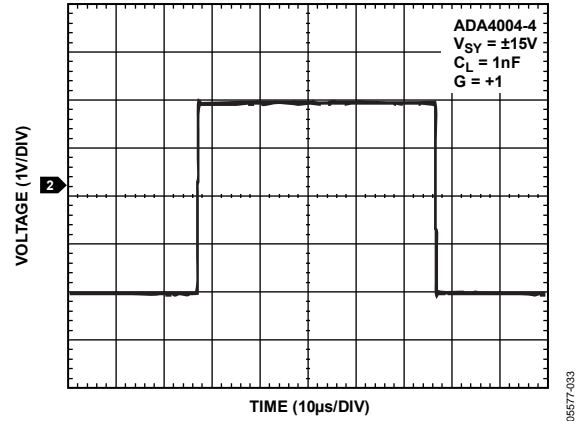

Figure 33. Large-Signal Transient Response

05577-033

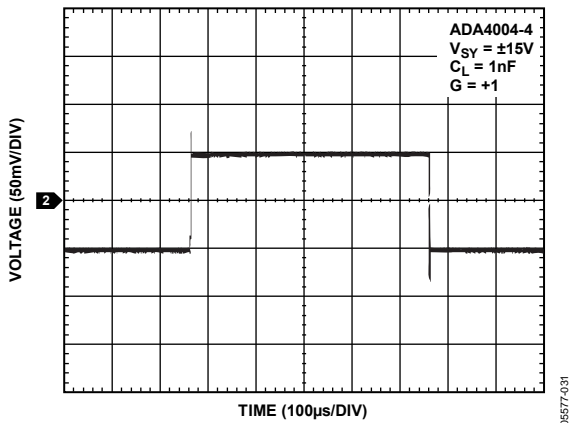

Figure 31. Small-Signal Transient Response

05577-031

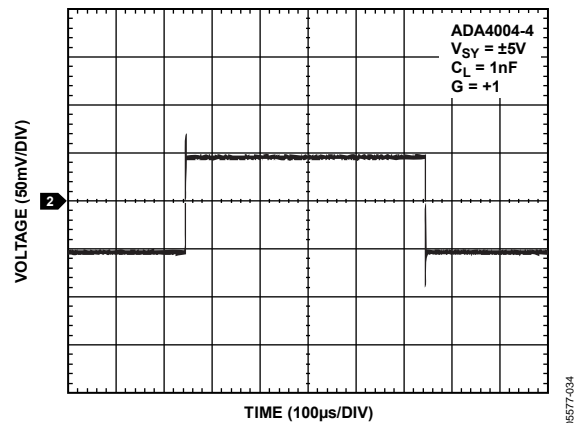

Figure 34. Small-Signal Transient Response

05577-034

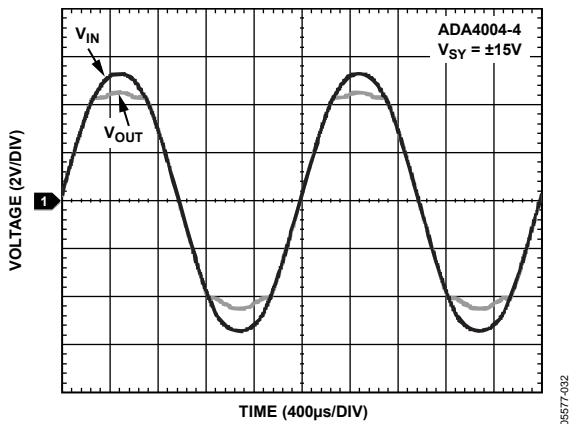

Figure 32. No Phase Reversal

05577-032

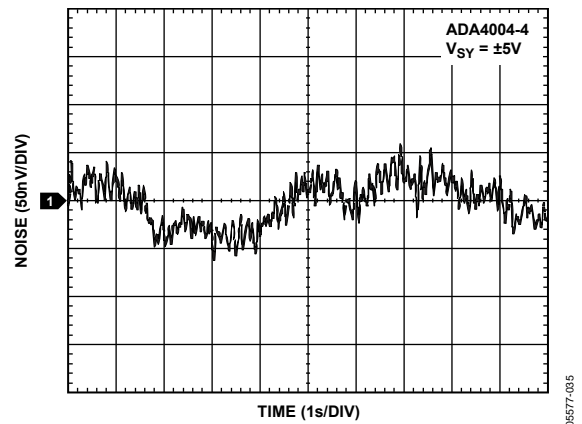

Figure 35. Voltage Noise (0.1 Hz to 10 Hz)

05577-035

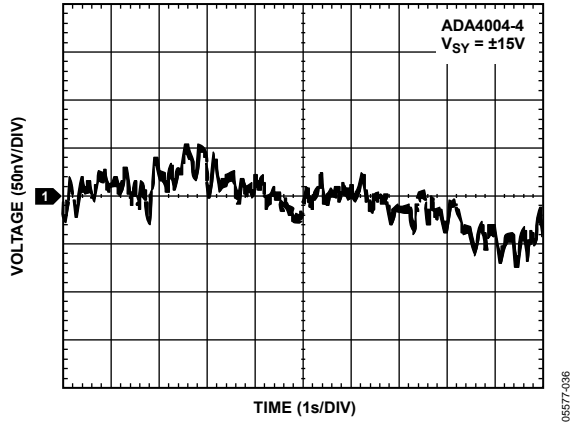

Figure 36. Voltage Noise (0.1 Hz to 10 Hz)

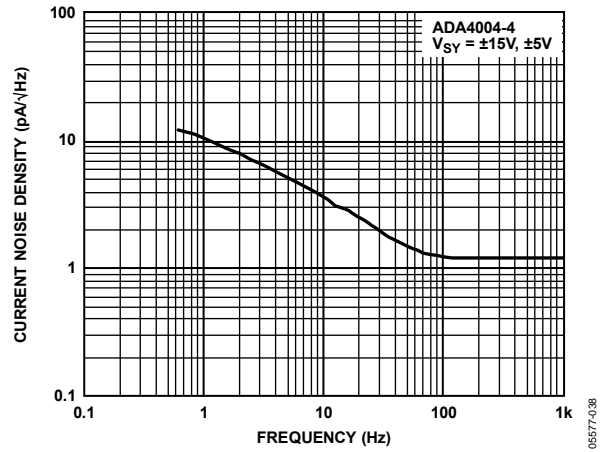

Figure 38. Current Noise Density vs. Frequency



Figure 37. Voltage Noise Density vs. Frequency

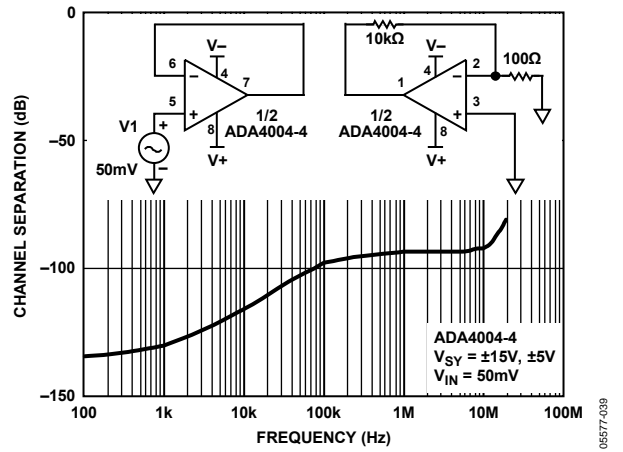
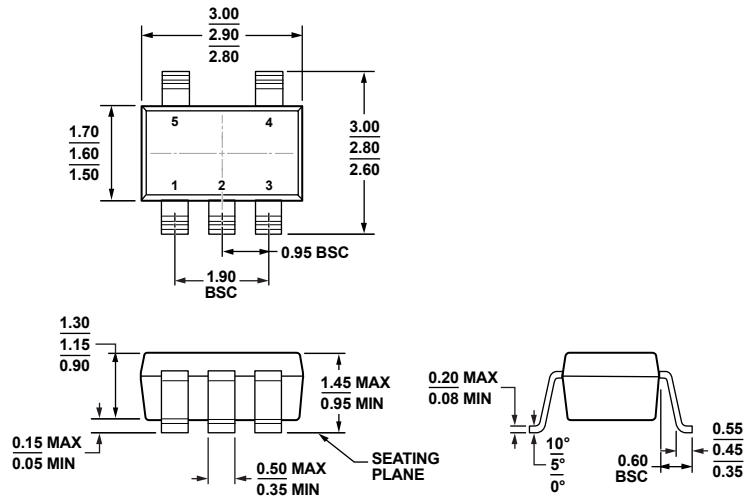

Figure 39. Channel Separation vs. Frequency

OUTLINE DIMENSIONS



COMPLIANT TO JEDEC STANDARDS MO-178-AA

Figure 40. 5-Lead Small Outline Transistor Package [SOT-23] (RJ-5)

Dimensions shown in millimeters

11-01-2010-A

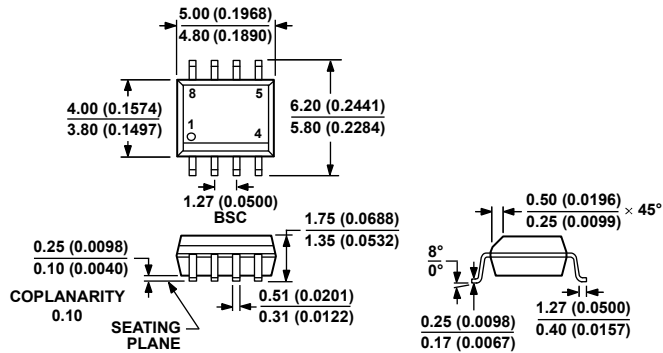

COMPLIANT TO JEDEC STANDARDS MS-012-AA

CONTROLLING DIMENSIONS ARE IN MILLIMETERS; INCH DIMENSIONS (IN PARENTHESES) ARE ROUNDED-OFF MILLIMETER EQUIVALENTS FOR REFERENCE ONLY AND ARE NOT APPROPRIATE FOR USE IN DESIGN.

Figure 41. 8-Lead Standard Small Outline Package [SOIC_N] Narrow Body (R-8)

Dimensions shown in millimeters and (inches)

012407-A

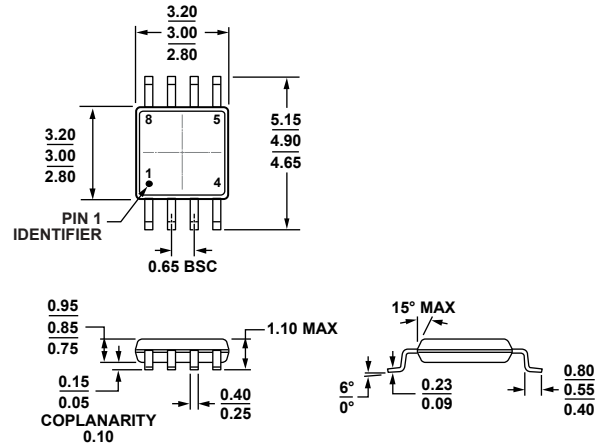

COMPLIANT TO JEDEC STANDARDS MO-187-AA

Figure 42. 8-Lead Mini Small Outline Package [MSOP] (RM-8)

Dimensions shown in millimeters

10-07-2008-B

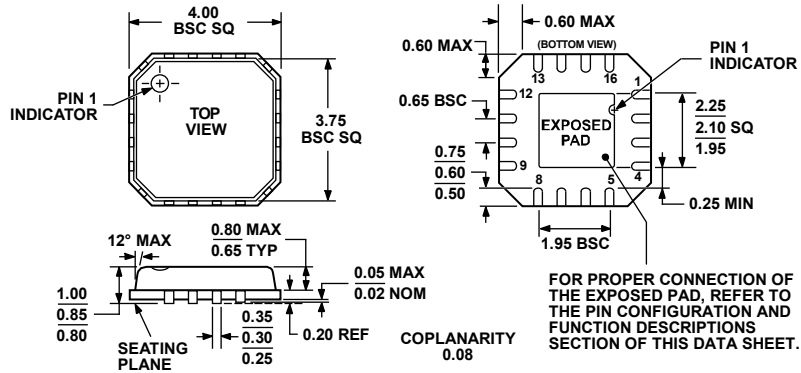

COMPLIANT TO JEDEC STANDARDS MO-220-VGGC

Figure 43. 16-Lead Lead Frame Chip Scale Package [LF CSP_VQ] 4 mm x 4 mm Body, Very Thin Quad (CP-16-4)

Dimensions shown in millimeters

072008-A

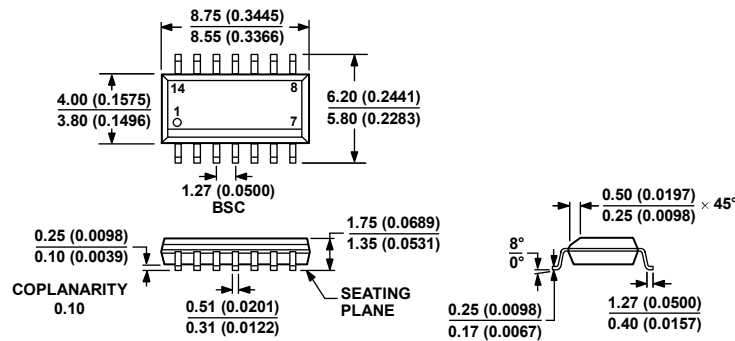

COMPLIANT TO JEDEC STANDARDS MS-012-AB

CONTROLLING DIMENSIONS ARE IN MILLIMETERS; INCH DIMENSIONS (IN PARENTHESES) ARE ROUNDED-OFF MILLIMETER EQUIVALENTS FOR REFERENCE ONLY AND ARE NOT APPROPRIATE FOR USE IN DESIGN.

Figure 44. 14-Lead Standard Small Outline Package [SOIC_N] Narrow Body (R-14)

Dimensions shown in millimeters and (inches)

060606-A

ADA4004-1/ADA4004-2/ADA4004-4

ORDERING GUIDE

Model ¹	Temperature Range	Package Description	Package Option	Branding
ADA4004-1ARJZ-R2	-40°C to +125°C	5-Lead SOT-23	RJ-5	A1M
ADA4004-1ARJZ-R7	-40°C to +125°C	5-Lead SOT-23	RJ-5	A1M
ADA4004-1ARJZ-RL	-40°C to +125°C	5-lead SOT-23	RJ-5	A1M
ADA4004-1ARZ	-40°C to +125°C	8-Lead SOIC_N	R-8	
ADA4004-1ARZ-R7	-40°C to +125°C	8-Lead SOIC_N	R-8	
ADA4004-1ARZ-RL	-40°C to +125°C	8-Lead SOIC_N	R-8	
ADA4004-2ARMZ	-40°C to +125°C	8-Lead MSOP	RM-8	A1N
ADA4004-2ARMZ-RL	-40°C to +125°C	8-Lead MSOP	RM-8	A1N
ADA4004-2ARMZ-R7	-40°C to +125°C	8-Lead MSOP	RM-8	A1N
ADA4004-2ARZ	-40°C to +125°C	8-Lead SOIC_N	R-8	
ADA4004-2ARZ-RL	-40°C to +125°C	8-Lead SOIC_N	R-8	
ADA4004-2ARZ-R7	-40°C to +125°C	8-Lead SOIC_N	R-8	
ADA4004-4ACPZ-R2	-40°C to +125°C	16-Lead LFCSP_VQ	CP-16-4	
ADA4004-4ACPZ-R7	-40°C to +125°C	16-Lead LFCSP_VQ	CP-16-4	
ADA4004-4ACPZ-RL	-40°C to +125°C	16-Lead LFCSP_VQ	CP-16-4	
ADA4004-4ARZ	-40°C to +125°C	14-Lead SOIC_N	R-14	
ADA4004-4ARZ-R7	-40°C to +125°C	14-Lead SOIC_N	R-14	
ADA4004-4ARZ-RL	-40°C to +125°C	14-Lead SOIC_N	R-14	

¹ Z = RoHS Compliant Part.

NOTES

NOTES